

# ACS1 Control Stick

## Quick Start Guide

Version 1.0 **EN**

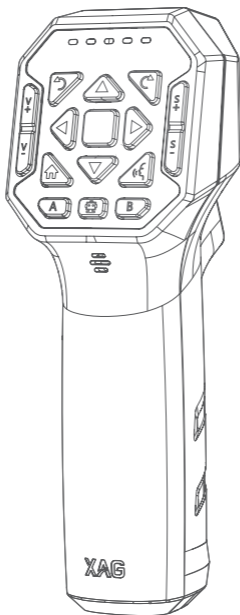



## To Users

Dear user, thank you for choosing XAG products.

For safety reasons and to ensure the best experience possible, XAG recommends that you read through the Quick Start Guide and Disclaimer in this document before attempting to use the ACS1 ControlStick.

## Contact Us

If you have any questions about this document, please contact our Technical Support via email: [info@xa.com](mailto:info@xa.com)

## List of Items

Before unpacking and using the product, please carefully check to see if it contains all the items listed in this list. Please contact XAG or your dealer if there are any missing items.

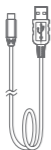

USB To Type-C  
Cable  
x 1



Micro USB To Type-C  
Cable  
x 1

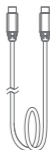

Type-C To Type-C  
Cable  
x 1

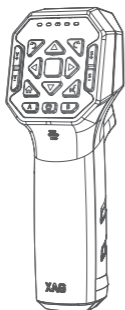

ACS1 RC (Body)  
x 1

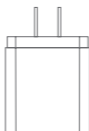

Power Adapter (Type A)  
x 1

# Overview

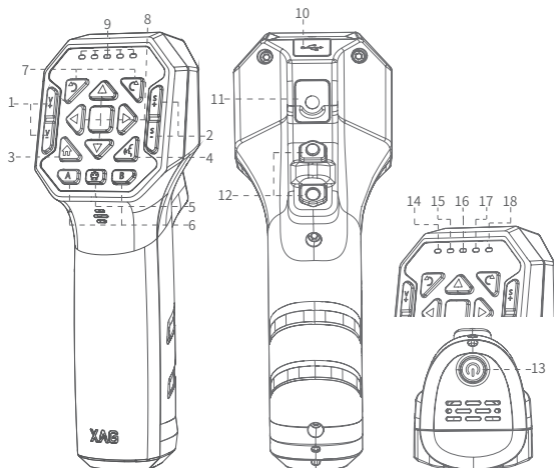

1 Speed Control

2 Spray/Spread Control

3 RTH

4 Terrain Follow

5 Smart Mode

6 A/B Button

7 Yaw Control

8 Directional Control

9 Status LEDs

10 Data Port (Type-C)

11 Heat Sink

12 Altitude Control

13 Power Button

14 LEDs - Battery Status

15 LEDs - Device Connection

16 LEDs - Aircraft Status

17 LEDs - Flight Status

18 LEDs - Mission Status

## Remote Controller Overview

### Turning ON/OFF the ACS1

1. Press and hold the Power button until the five LEDs flash at the same time.
2. Release and then press and hold the Power button again until a voice prompt is heard from the ControlStick.

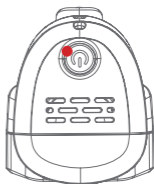

Notes: Within one minute of being powered on, the UAV Connection light flashes green slowly, indicating that the communication module is starting.

All the “press and hold” mentioned herein means “press and hold for 2 seconds”, unless otherwise specified.

### Connecting to Smart Device (A3/Android Phone)

1. Open Hotspot settings on your Smart Device, Set Hotspot name and Password (Default) to:  
(Default) Hotspot Name: XAG123  
(Default) Hotspot Password: 20070401  
Then, Turn on the Hotspot
2. Open XAG AGRI APP, and wait for connection. (  icon turns green)

Notes: Please keep the Smart device at a distance of 20cm-10m away from the ControlStick. Do not keep the two devices too close, to prevent signal interference.

# Parameters Setting

1. On the XAG AGRI APP, select the  Icon (01)
2. Select "Edit" to enter Parameters Settings Menu (02)

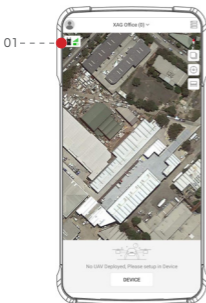

1

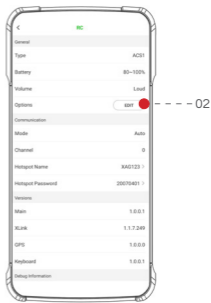

2

3. Parameters Settings Menu for Flight



3

## Manual Control

Press and hold both Altitude Control buttons for 3 seconds, and the UAV will automatically take off and hover at 2.5 meters.

If the Altitude Control buttons are released within 3 seconds, it will cancel the Take-off command.

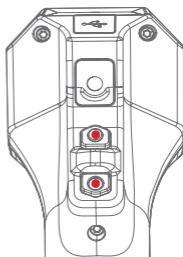

- Altitude control

1. Increase Altitude: Press and hold the Up button above
2. Decrease Altitude: Press and hold the Down button below

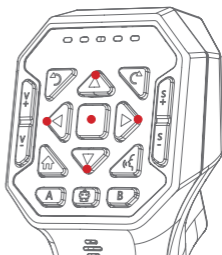

- Directional Control

1. Directional control: Pilot the UAV Forward/Backward or Sideway.
2. Hover Button: Suspend the UAV movement and Hover the UAV.





- Yaw Control

1.  Rotate UAV CCW (Counter Clockwise)
2.  Rotate UAV CW (Clockwise)

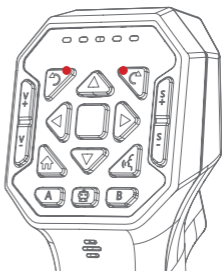

- Land/RTH

Land : While airborne, Press and hold both Altitude Control Buttons to land the UAV (Left figure)

RTH : Press and hold the RTH button to RTH (Return to Home) (Right figure)

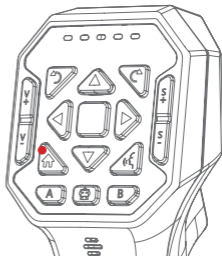
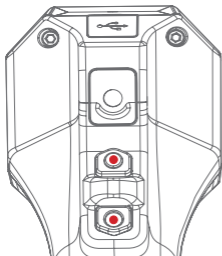

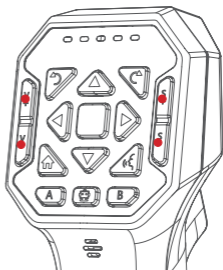

- Speed control

V+ : Increase Speed

V- : Decrease Speed

- Enable/Disable Spray Mode

S+ : Press and Hold to enable Spray Mode

S- : Press and Hold to disable Spray Mode

Note : Spray mode cannot be enabled during Hover Mode.

- Spray Rate / Spread Volume Control

S+ : Increase Rate/Volume

S- : Decrease Rate/Volume

Note : During Manual control of the UAV by the ACS1, the ACS Flight Status LEDs will be green and the UAV is switched to Manual Mode.

The Aircraft status indicator will display double flashes in green. If the UAV was interrupted during autonomous mode by the ACS1, press and hold the Hover Button to re-enter Autonomous Mode, then choose to resume the original route via the APP.

## AB Point Mode

### 1. Defining points

- ① . Fly the UAV to the designated location, press the A button twice to define the location as Point A
- ② . Fly the UAV to the designated location, press the B button twice to define the location as Point B

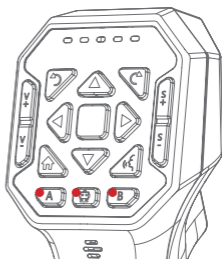

### 2. Activating the AB Mode

Smart Mode : Press and Hold to enable AB Mode.

A Button : Press to command the UAV to start operating from the right towards the left (Left Route).

B Button : Press to command the UAV to start operating from the left towards the right (Right Route).

Note : Route can not be changed once A/B Route had been selected.

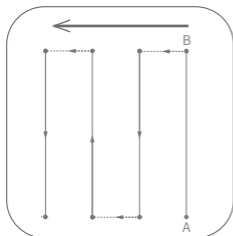

Left route

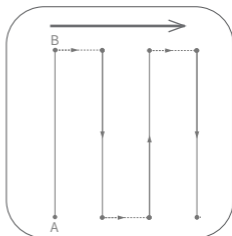

Right route

### 3 . Change Route

- ① . Switch to manual mode: Press and hold the Smart Mode button until a voice prompt
- ② . Press the A/B button to select another route

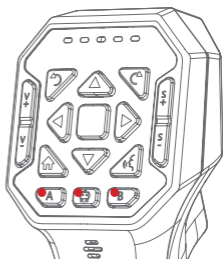

### 4 . Exit Operation

Press any directional control or Smart Mode button.



## Others

### Checking Battery level

When the ControlStick is off, press the Power button once and the five status LEDs will display the current battery level (see below).

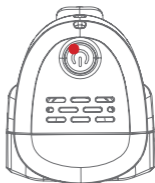

When the ControlStick is on, battery level is indicated by the Status LEDs (see page 11-12).



1 green light on		Battery Level 5%~20%
2 green lights on		Battery Level 20%~40%
3 green lights on		Battery Level 40%~60%
4 green lights on		Battery Level 60%~80%
5 green lights on		Battery Level 80%~100%

## Charging

Recharge the ACB Control Stick with the provided adapter and Type-C Cable. Charging status is indicated by the battery status LEDs.

LED Display*		Status
Quick flash(Green)		Quick Charge Mode
Slow flash (Green)		Slow Charge Mode
Solid Green		Fully charged

## Status LEDS Indication (Left to Right)

Battery Status LEDS		Status
Quick flash (green)		Quick Charge Mode
Slow flash (green)		Slow Charge Mode
Green light on		Power level 60%~100%
Yellow light on		Power level 20%~59%
Red light on		Power level 5%~29%

Device Connection LEDS		Status
Green light on		Connected
Off		Disconnected
Red light on		Connection fault

Aircraft Status LEDS		Status
Slow flash (green)		Module starting
Green light on		UAV connected
Off		No UAV paired
Red light on		Connection fault

Flight Status LEDS		Status
Green light on		Manual Mode
Off		Autonomous Mode

## Firmware Update

1. Open XAG AGRI APP.
2. Open Menu and access Devices page.
3. Tab on the ACS1 icon to bring up sub menu and select "Update".
4. Select the items for update, and then select "Update now".
5. After the download is completed, turn OFF the ACS1.
6. Turn ON the ACS1, and the Status LEDs will flash in red indicating the ACS1 is currently updating its firmware. Once the update is completed, the ACS1 will automatically turn off.

### Firmware Update (Manual Update via PC):

1. When the ACS1 is off, press and hold the Down button (altitude control) and the Power button until all the status LEDs are turned on and in red, indicating the ControlStick is under the USB flash drive mode.
2. Connect the ACS1 to the PC, and wait for a flash drive is detected on the PC, then copy the .fw file into the drive.
3. Unplug the cable, and then press and hold the Down button (altitude control) and the Power button until all the status LEDs are off.
4. Turn ON the ACS1, and the Status LEDs will flash in red indicating the ACS1 is currently updating its firmware. Once the update is completed, the ACS1 will automatically turn off.



## Technical Specifications

•Model	ACS1
•Dimensions	175mm×60mm×68mm
•Operating Frequency	2.4Ghz/5.8GHz
•Transmitting power	23dbm
•Supported OS	Android
•Built-in battery capacity	3500 mAh /25 Wh
•Charging Temperature	5°C - 45°C
•Charging voltage/current	5V/2A, 9V/1.5A, 12V/1.5A
•Max Transmission Distance (No interference/obstruction)	800 m
•Mesh network	Supported
•Voice broadcast	Supported
•Operating temperature	-20°C - 60°C
•Ingress Protection	IP 54

## Disclaimer

1. Please read this document carefully before using this product. This Disclaimer has an important impact on the safe use of the product and your legitimate rights and interests. The use of the product shall be deemed as you have known, understood, acknowledged, and accepted all terms and contents of this document.
2. This product is not a toy, and is not suitable for people under the age of 18. Please keep this product away from the reach of children, and be very careful when operating in the presence of children.
3. Please assemble and use this product in strict accordance with the "Product Manual/Operation Manual". Do not modify or disassemble the product without authorization. The user shall bear all losses arising from his or her unauthorized modification or disassembly of this product, for which XAG may not be held liable.
4. To the maximum extent permitted by law, XAG shall not be liable for all losses caused by users' failure to use the product in accordance with this document and the "Product Manual/Operation Manual".
5. To the maximum extent permitted by law, the liability or amount of XAG under any circumstances to you for all damages, losses, and litigation arising therefrom will not exceed the amount paid to XAG by you for the purchase of the product.
6. In any case, the purchaser or user shall comply with relevant laws and regulations of the country and region where the product is used. XAG does not assume any liability arising from violation of relevant laws and regulations by the purchaser or user.
7. As laws in some countries may prohibit exemptions from liability clauses, your rights in different countries may vary. This does not mean that the contents of this Disclaimer are necessarily invalid.
8. To the extent permitted by law, XAG has the final right to interpret and modify the above terms. XAG has the right to update, modify, or terminate these terms through its official website, the "Product Manual/Operation Manual", online APP and other means without prior notice.

## Warning

Users are required to read the complete "Product Manual" and be familiar with the product operations before using the product. Otherwise, it may cause serious injury to yourself or others, or cause product damage and property loss. Strong safety awareness is required to operate this product. Do not use the parts that are not provided or suggested by XAG. Please strictly follow the instructions of XAG to install and use the product.

### Certificate of Inspection

This product has  
passed inspection.



Scan the QR code  
Download XAG AGRI App

Visit our website for more information  
[www.xa.com/en](http://www.xa.com/en)

This Guide is subject to update with-  
out prior notice.



[info@xa.com](mailto:info@xa.com)



[@XAGofficial](https://www.facebook.com/XAGofficial)



[@XAG\\_official](https://twitter.com/XAG_official)



[@XAG Official](https://www.youtube.com/XAGOfficial)